

# Temperature Indicating Materials General Product Catalog



Ever since 1965, NiGK Corporation has been responding to diverse market needs by developing products that use color change to convey temperature, UV and dew levels at a single glance.

Our products can be largely divided into categories according to purpose: temperature indicating materials; temperature indicating materials for food sterilization process; temperature indicating materials for process control; UV detection products; and dew detection products.

Cautions on Use ..... 01

## Temperature Indicating Materials

Temperature label LI ..... 02

Temperature label 3E ..... 02

Temperature label 4E ..... 03

Temperature label 5E ..... 03

Temperature label 8E ..... 03

Temperature label F ..... 03

Temperature label Super Mini 1K ..... 04

Temperature label Super Mini 3K ..... 04

Temperature label Super Mini 3R ..... 04

Temperature label Mini ..... 05

Temperature label 5S ..... 05

THERMO TAPE™ ..... 06

THERMO SHEET™ P-5·7 ..... 06

THERMO SHEET™ C ..... 06

Number THERMO WAPPEN™ ..... 07

Combination label A ..... 07

Combination label TB ..... 07

Temperature label for Vacuums ..... 08

Thermo Proof ..... 08

DEGMARK™ ..... 09

DIGITAL THERMO TAPE™ ..... 09

## Ultraviolet indicating material

UV LABEL™ ..... 10

Customized UV LABEL™ (UV LABEL™ Application Products) ..... 10

UV LABEL for LED™ ..... 11

## Heat sterilization indicating material

RETOMARK™ ..... 12

## Dew indicating material

DEW LABEL™ ..... 12

## Usage Examples and Product List

Temperature Indicator Usage Examples ..... 13~16

Product List ..... 17

## Product Functionality

Reversible	Changes color when a certain temperature is reached then changes back when the temperature drops. Can be used repeatedly.	For checking the current temperature
Irreversible	<ul style="list-style-type: none"> <li>Changes color when a certain temperature is reached, but does not change back even if the temperature drops.</li> <li>Changes color when UV intensity increases, but does not change back even in dark places.</li> <li>Changes color due to moisture from dew, but does not change back even if dry.</li> </ul>	For checking temperature history For detecting UV light For checking for dew
Semi-irreversible	Changes color as the temperature rises then changes back with moisture when the temperature drops.	For temperature measurement

## Cautions on Use

### Temperature label , THERMO TAPE™ , THERMO SHEET™ and THERMO WAPPEN™

Characteristics and usage methods of products presented in this catalog vary from type to type. To ensure proper use, please read carefully beforehand the cautions in this section and cautions given with product descriptions, as well as usage instructions provided with the product. Please direct any questions to NiGK Corporation Sales.

### Color Changes

- In this catalog, color-change temperature and color-change accuracy refer to the temperature and degree of accuracy at completion of a color change after heating from room temperature at a rate of between 2 and 3°C/min under normal pressure. The actual color-change temperature may differ under particular heating conditions.
- Reversible temperature indicating materials that change color at 50°C (low-temperature color: yellow) may change to an other color if exposed to direct sunlight. This is a temporary phenomenon and the color will lighten over time. Temperature detection capability will not be affected.
- Reversible temperature indicating materials change color with an accuracy of ±2°C when the temperature is increasing. However, the color returns to its original color at the temperature between 15 and 30°C lower than the specified temperature when cooling at a rate of between 1 and 2°C/min.
- Temperature-indicating pigment of reversible temperature indicating materials may react to Bakelite surfaces, resulting in an inaccurate color change.
- The performance of irreversible temperature labels which change color at 130°C or higher may be changed if it is exposed to temperatures in the -10°C from the specified temperature.
- The temperature-indicating element of irreversible temperature labels may show slight coloration even before the temperature increases, but performance will not be affected and it will be obvious when the color changes at the specified temperature.

### Affixing Labels

- Make sure to clear the surface of all water, oil, rust, dust and dirt. Dirty or uneven surfaces could result in the label falling off or an inaccurate color change.
- To affix the label, peel off the release liner and apply the label to the surface on which the temperature is to be measured, gently pressing down on it with your finger or a cloth. Avoid strong rubbing, which may scratch the label or cause other damage affecting the ability of the product to indicate temperature properly.
- Where possible, affix the label to a flat surface as curved surfaces and corners could lead to an inaccurate color change.
- Do not alter the shape of a label. Modifying a label, for example by cutting it with a utility knife, may affect the label's durability or lead to an inaccurate color change. (This does not apply to Thermo Tape™.)

### Usage and Storage Environments

- Do not use products in high-pressure or high-vacuum environments, or in microwave ovens or other induction heating applications, as it could lead to an inaccurate color change.
- Store in a cool dark place prior to use. Products specified as requiring cold storage should be kept refrigerated.
- Products specified for indoor applications should be used indoors. Using these products in conditions where they are exposed to the effects of substances such as water, oil, solvents and plasticizers (e.g. through surface adhesion, soaking from underneath, or in atmospheres consisting of such substances) may lead to an inaccurate color change.
- NiGK Corporation will not accept any liability for damages incurred as a result of using the product or applying measurements given by the products.

#### ●Period of Effectiveness of Temperature Indicating Materials

Product	Type	Indoor use	Outdoor use
Temperature label	LI · F · 3E 4E · 5E · 8E	5 years	3 years
Temperature label	5S	3 years	Not suitable
Temperature label Super mini	1K · 3K · 3R		
Temperature label Mini	No.		
Combination label	A · TB	5 years	3 years

Product	Type	Indoor use	Outdoor use
THERMO TAPE™	TR	5 years	3 years
THERMO SHEET™	P · C		
Number THERMO WAPPEN™	WR		

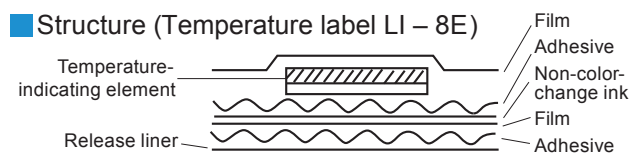

**Features**

- This temperature label changes color at the specified temperature. It is an irreversible temperature indicator, meaning that once the color changes it will not return to its original state.
- The temperature-indicating element is sealed by heat-resistant film, protecting it from water, chemicals, oil and the surrounding atmosphere. (LI, F, 3E, 4E, 5E, 8E, and Combination)
- The backing of the temperature label is coated with heat-resistant adhesive, meaning the release liner simply needs to be peeled off before affixing the label to the area where the temperature is to be measured.

**LI**

- Single temperature indicating model

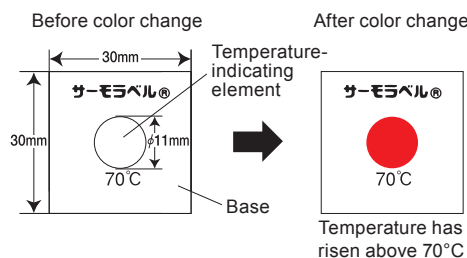

\* The diameter of the temperature-indicating element is 11mm for LI-40 to 105, and 8mm for LI-110 to 250.

Type	Color-change temperature °C	Before color change	After color change	Color-change accuracy*	JAN code	Type	Color-change temperature °C	Before color change	After color change	Color-change accuracy*	JAN code
LI-40	40	White	Blue	±2°C	4582130420010	LI-120	120	White	Blue	±2°C	4582130420171
LI-45	45	White	Black		4582130420027	LI-125	125	White	Black		4582130420188
LI-50	50	White	Red		4582130420034	LI-130	130	White	Black		4582130420195
LI-55	55	White	Deep indigo		4582130420041	LI-140	140	White	Black		4582130420201
LI-60	60	White	Green		4582130420058	LI-150	150	White	Black		4582130420218
LI-65	65	White	Black		4582130420065	LI-160	160	White	Black		4582130420225
LI-70	70	White	Red-orange		4582130420072	LI-170	170	Pale yellow	Black		4582130420232
LI-75	75	White	Dark red		4582130420089	LI-180	180	Pale yellow	Black		4582130420249
LI-80	80	White	Blue		4582130420096	LI-190	190	Pale yellow	Black		4582130420256
LI-85	85	White	Deep indigo		4582130420102	LI-200	200	Pale yellow	Black		4582130420263
LI-90	90	White	Red		4582130420119	LI-210	210	Pale yellow	Black		4582130420270
LI-95	95	White	Black		4582130420126	LI-220	220	Pale yellow	Black		4582130420287
LI-100	100	White	Dark red		4582130420133	LI-230	230	Pale yellow	Black		4582130420294
LI-105	105	White	Green		4582130420140	LI-240	240	Pale yellow	Black		4582130420300
LI-110	110	White	Deep indigo		4582130420157	LI-250	250	Pale yellow	Black		4582130420317
LI-115	115	White	Red-orange	4582130420164							

40 labels per box

**3E**

- 3 temperatures at 10°C intervals

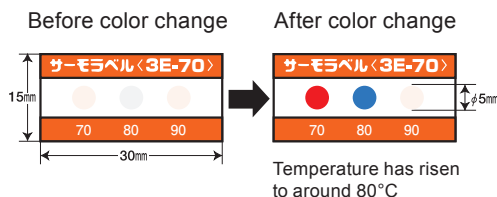

\* Label dimensions are 15×30mm for 3E-40 to 110, and 17×32mm for 3E-120 to 230.

Type	Temperature combination (°C)	Color-change accuracy*	JAN code	Type	Temperature combination (°C)	Color-change accuracy*	JAN code	
3E-40	40-50-60	±2°C	4582130420485	3E-110	110-120-130	±2°C	4582130420621	
3E-45	45-55-65		4582130420492	3E-120	120-130-140		4582130420638	
3E-50	50-60-70		4582130420508	3E-130	130-140-150		4582130420645	
3E-55	55-65-75		4582130420515	3E-140	140-150-160		4582130420652	
3E-60	60-70-80		4582130420522	3E-150	150-160-170		4582130420669	
3E-65	65-75-85		4582130420539	3E-160	160-170-180		4582130420676	
3E-70	70-80-90		4582130420546	3E-170	170-180-190		4582130420683	
3E-75	75-85-95		4582130420553	3E-180	180-190-200		4582130420690	
3E-80	80-90-100		4582130420560	3E-190	190-200-210		4582130420706	
3E-85	85-95-105		4582130420577	3E-200	200-210-220		4582130420713	
3E-90	90-100-110		4582130420584	3E-210	210-220-230		4582130420720	
3E-95	95-105-115		4582130420591	3E-220	220-230-240		4582130420737	
3E-100	100-110-120		4582130420607	3E-230	230-240-250		4582130420744	
3E-105	105-115-125		4582130420614					

\* Color changes at each temperature are the same as for LI.

20 labels per box

# Temperature label

**POINT!!** Stepped indication at 5°C or 10°C intervals

**4E**  
● 4 temperatures at 5°C intervals

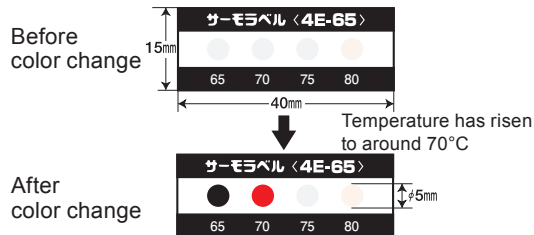

\* Color changes at each temperature are the same as for temperature label LI.

Type	Temperature combination (°C)	Color-change accuracy	JAN code
4E-50	50-55-60-65	±2°C	4582130420751
4E-55	55-60-65-70		4582130420768
4E-60	60-65-70-75		4582130420775
4E-65	65-70-75-80		4582130420782
4E-70	70-75-80-85		4582130420799

Type	Temperature combination (°C)	Color-change accuracy	JAN code
4E-75	75- 80- 85- 90	±2°C	4582130420805
4E-80	80- 85- 90- 95		4582130420812
4E-85	85- 90- 95-100		4582130420829
4E-90	90- 95-100-105		4582130420836
4E-95	95-100-105-110		4582130420843

20 labels per box

**5E**  
● 5 temperatures at 5°C or 10°C intervals

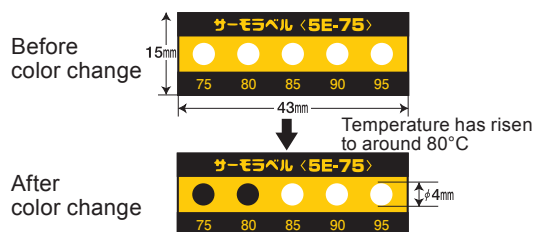

\* Label dimensions are 15×43mm for 5E-50 to 100, and 17×45mm for 5E-125 to 210.

Type	Temperature combination (°C)	Before color change	After color change	Color-change accuracy	JAN code
5E- 50	50- 55- 60- 65- 70	White	Black	±2°C	4582130420850
5E- 75	75- 80- 85- 90- 95	White	Black		4582130420867
5E-100	100-105-110-115-120	White	Black		4582130420874

Type	Temperature combination (°C)	Before color change	After color change	Color-change accuracy	JAN code
5E-125	125-130-140-150-160	White	Black	±2°C	4582130420881
5E-170	170-180-190-200-210	Pale yellow	Black	±2~3°C	4582130420898
5E-210	210-220-230-240-250	Pale yellow	Black	±3°C	4582130420904

20 labels per box

**8E**  
● 8 temperatures at 10°C intervals

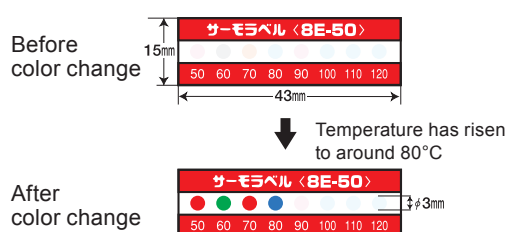

\* Color changes at each temperature are the same as for temperature label LI.

Type	Temperature combination (°C)	Color-change accuracy	JAN code
8E-50	50-60-70-80-90-100-110-120	±2°C	4582130420911
8E-90	90-100-110-120-130-140-150-160		4582130423196

20 labels per box

**F**  
● For small spaces on indoor/outdoor equipment

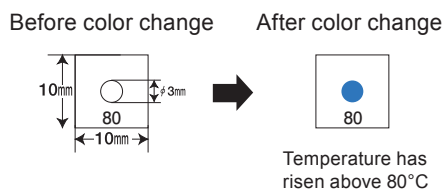

Type	Color-change temperature (°C)	Before color change	After color change	Color-change accuracy	JAN code
F-50	50	White	Red	±2°C	4582130420324
F-55	55	White	Deep indigo		4582130420331
F-60	60	White	Green		4582130420348
F-65	65	White	Black		4582130420355
F-70	70	White	Red-orange		4582130420362
F-75	75	White	Dark red		4582130420379
F-80	80	White	Blue		4582130420386
F-85	85	White	Deep indigo		4582130420393

Type	Color-change temperature (°C)	Before color change	After color change	Color-change accuracy	JAN code
F- 90	90	White	Red	±2°C	4582130420409
F- 95	95	White	Black		4582130420416
F-100	100	White	Dark red		4582130420423
F-105	105	White	Green		4582130420430
F-110	110	White	Deep indigo		4582130420447
F-115	115	White	Red-orange		4582130420454
F-120	120	White	Blue		4582130420461
F-125	125	White	Black		4582130420478

40 labels per box

**Applications**

- Indoor/outdoor monitoring of heat generation/heating temperature
- Monitoring of heat treatment
- Inspection of heat generation by power substation equipment/plant machinery
- Temperature monitoring during distribution



# Temperature label Super mini

Irreversible

**POINT!!** For temperature monitoring of small parts

## Features

- Temperature label Super mini and Mini are extremely small labels.
- These labels are widely used for monitoring the temperature of small parts.

### 1K

- Mini-sized labels (5×5mm)
- Single temperature indicating model



Before color change

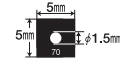

After color change



Temperature has risen to around 70°C

\* The white dot disappears when the color-change temperature is reached (same for 1K, 3K and 3R)

Type	Color-change temperature °C	Color-change	Color-change accuracy	JAN code	Type	Color-change temperature °C	Color-change	Color-change accuracy	JAN code
1K-40	40	White ↓ Black	±2°C	4582130420928	1K-85	85	White ↓ Black	±2°C	4582130421017
1K-45	45			4582130420935	1K-90	90			4582130421024
1K-50	50			4582130420942	1K-95	95			4582130421031
1K-55	55			4582130420959	1K-100	100			4582130421048
1K-60	60			4582130420966	1K-105	105			4582130421055
1K-65	65			4582130420973	1K-110	110			4582130421062
1K-70	70			4582130420980	1K-115	115			4582130421079
1K-75	75			4582130420997	1K-120	120			4582130421086
1K-80	80	4582130421000	1K-125	125	4582130421093				

200 labels per box

### 3K

- Mini-sized 3-temperature type



Before color change

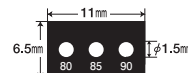

After color change



Temperature has risen to around 85°C

Type	Temperature combination (°C)	Color-change	Color-change accuracy	JAN code
3K-40	40-45-50	White ↓ Black	±2°C	4582130421109
3K-50	50-55-60			4582130421116
3K-65	65-70-75			4582130421123
3K-80	80-85-90			4582130421130
3K-95	95-100-105			4582130421147
3K-110	110-115-120			4582130421154
3K-130	130-140-150			4582130421161

20 labels per box

### 3R

- Round mini-sized 3-temperature type



Before color change

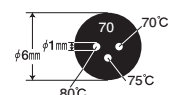

After color change



Temperature has risen to around 75°C

\* The first color-change temperature in the combination is represented by the white dot on the right-hand side beneath the indicated number. The temperatures continue in clockwise order.

Type	Temperature combination (°C)	Color-change	Color-change accuracy	JAN code
3R-40	40-45-50	White ↓ Black	±2°C	4582130421178
3R-50	50-55-60			4582130421185
3R-60	60-65-70			4582130421192
3R-70	70-75-80			4582130421208
3R-80	80-85-90			4582130421215
3R-90	90-95-100			4582130421222
3R-100	100-105-110			4582130421239
3R-110	110-115-120			4582130421246
3R-120	120-125-130			4582130421253
3R-130	130-140-150			4582130421260

20 labels per box

## Applications

- Monitoring for abnormal heat generation of electronic parts such as transistors, ICs, LSIs, resistors, capacitors, and inductors
- Inspection of heat generation by small motors such as circuit cooling fan motors and drive motors
- Checking the ambient temperature during product transportation or use

Irreversible

# Temperature label Mini

**POINT!!** Single temperature indicating model

## Mini

- Ideal for monitoring the temperature of small parts

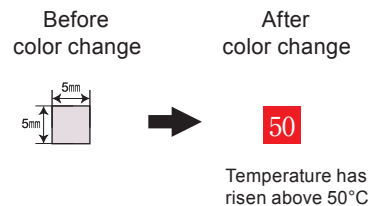

Type	Color-change temperature °C	Color-change	Color-change accuracy	JAN code
No.50	50	White ↓ Red	±2°C	4582130421277
No.55	55			4582130421284
No.60	60			4582130421291
No.65	65			4582130421307
No.70	70			4582130421314
No.75	75			4582130421321
No.80	80			4582130421338
No.85	85			4582130421345

Type	Color-change temperature °C	Color-change	Color-change accuracy	JAN code
No.90	90	White ↓ Red	±2°C	4582130421352
No.95	95			4582130421369
No.100	100			4582130421376
No.105	105			4582130421383
No.110	110			4582130421390
No.115	115			4582130421406
No.120	120			4582130421413
No.125	125			4582130421420

200 labels per box

Irreversible

# Temperature label S

**POINT!!** 5-temperature stepped indication at 5°C intervals

## Features

- Temperature indicator label 5S has 5 temperatures on a single label, making it ideal for temperature measurements in test situations.

## 5S

- Ideal for monitoring the temperature of small parts

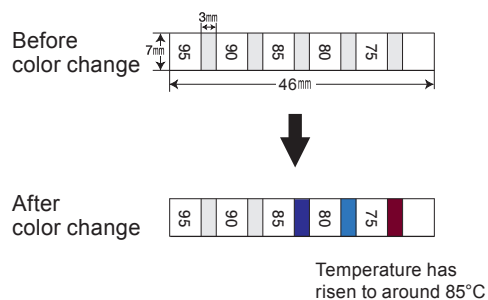
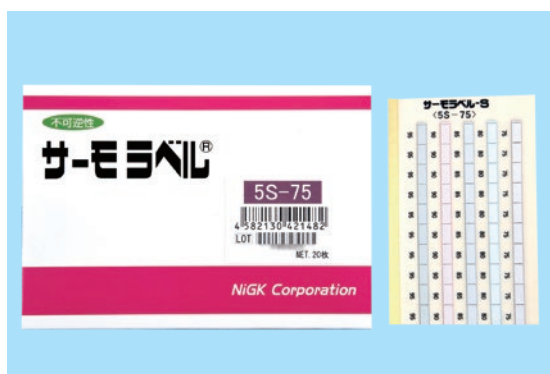

\* Color changes at each temperature are the same as for LI.

Type	Temperature combination (°C)	Color-change accuracy	JAN code
5S-50	50- 55- 60- 65- 70	±2°C	4582130421437
5S-55	55- 60- 65- 70- 75		4582130421444
5S-60	60- 65- 70- 75- 80		4582130421451
5S-65	65- 70- 75- 80- 85		4582130421468
5S-70	70- 75- 80- 85- 90		4582130421475
5S-75	75- 80- 85- 90- 95		4582130421482
5S-80	80- 85- 90- 95-100		4582130421499
5S-85	85- 90- 95-100-105		4582130421505
5S-90	90- 95-100-105-110		4582130421512
5S-95	95-100-105-110-115		4582130421529

20 labels per box

### Caution on Use

- Super mini, mini and S are designed for indoor use and therefore should be used only in indoor environments. Using these products in conditions where they are exposed to the effects of substances such as water, oil, solvents and plasticizers (e.g. through surface adhesion, soaking from underneath, or in atmospheres consisting of such substances) may lead to an inaccurate color change.

# Reversible THERMO TAPE™

**POINT!!** Strips showing the current temperature

## Features

- THERMO TAPE™ is a reversible indicator that changes color at the specified temperature and reverts to its original color when cooled. It can be used repeatedly.
- Both sides of the tape retain the original color (before changing), making any color change due to a rise in temperature obvious at a single glance.
- As a tape, it can be cut into strips of any length.

## TR

- Single temperature indicating model

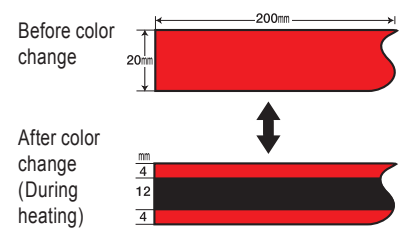

Type	Color-change temperature °C	Low-temperature color	High-temperature color	Color-change accuracy	JAN code
TR-40	40	Reddish yellow	Reddish orange	±2°C	4582130421536
TR-50	50	Yellow	Yellowish orange		4582130421543
TR-60	60	Bright yellowish red	Dark brown-purple		4582130421550
TR-70	70	Red	Dark brown-purple		4582130421567

25 labels per box

# Reversible THERMO SHEET™

**POINT!!** Temperature-indicating sheet

## Features

- Sheets with a combination of reversible temperature indicating materials. There are two types: 2-temperature and 5-temperature.
- The 2-temperature sheet is suitable for indicating warning and danger temperatures. (P-5·7)
- The 5-temperature sheet is suitable for measuring temperature and checking for temperature increases. (C)
- Color-change temperatures and color-change tones are the same as for Number THERMO WAPPEN™.

## P-5·7

- 2-temperature type

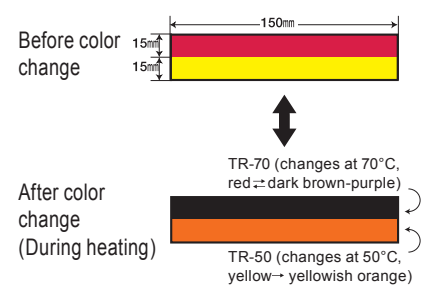

## C

- 5-temperature type

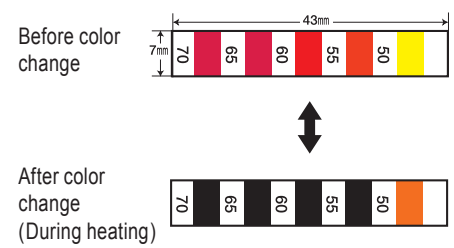

\* Color changes and color tones are the same as for Number THERMO WAPPEN™

Type	Color-change temperature °C	Qty per box	Color-change accuracy	JAN code
P-5·7	50-70	30	±2°C	4582130421574
C	50-55-60-65-70	100		4582130421581

### Applications

- Preventing burns during heating processes
- Monitoring of warning and danger temperatures



Features

- Number of heating temperature appears.
- The number disappears when the temperature drops, allowing repeated use.

WR

- Temperature appears in digital format

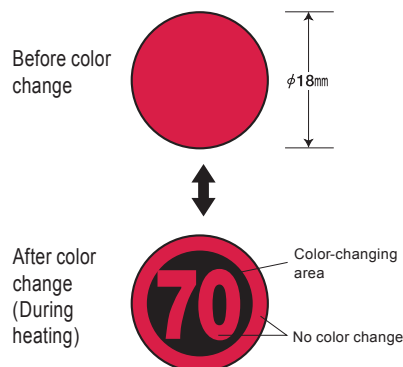

Type	Color-change temperature°C	Low-temperature color	High-temperature color	Color-change accuracy	JAN code
WR-40	40	Reddish yellow	Reddish orange	±2°C	4582130421598
WR-45	45	Yellowish orange	Bright yellowish red		4582130421604
WR-50	50	Yellow	Yellowish orange		4582130421611
WR-55	55	Yellowish red	Dark brown-purple		4582130421628
WR-60	60	Bright yellowish red	Dark brown-purple		4582130421635
WR-65	65	Red	Dark brown-purple		4582130421642
WR-70	70	Red	Dark brown-purple		4582130421659
WR-Mixed	50~70				4582130421666

\* WR-Mixed: 24 labels each for 50°C, 55°C, 60°C, 65°C and 70°C (120 labels per box)

120 labels per box

Irreversible + Reversible

## Combination label

POINT!! Check temperature history and current temperature

Features

- This combination label consists of an irreversible temperature-indicating element (temperature label) at the center of a reversible Thermo Sheet™ base.
- Trace temperature history with the irreversible label and current temperature with the reversible sheet.

A

- For checking past and current temperature

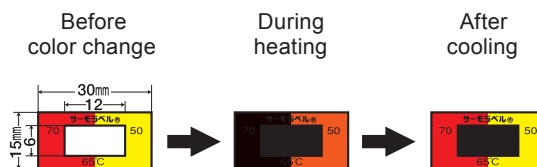
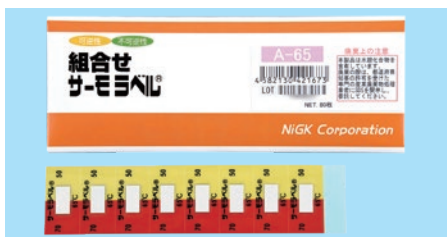

Type	Temperature-indicating element (irreversible)			Base (reversible)		JAN code
	Color-change temperature°C	Color-change	Size	Color-change temperature (Low-temperature color ↔ high-temperature color)	Size	
A-65	65	White → Black	6×12mm	70°C Red ↔ Dark brown-purple 50°C Yellow ↔ Yellowish orange	15×30mm	4582130421673
A-70	70	White → Red-orange				4582130421680
A-75	75	White → Dark red				4582130421697
A-80	80	White → Blue				4582130421703
A-85	85	White → Deep indigo				4582130421710
A-90	90	White → Red				4582130421727

80 labels per box

TB

- For checking past and current temperature

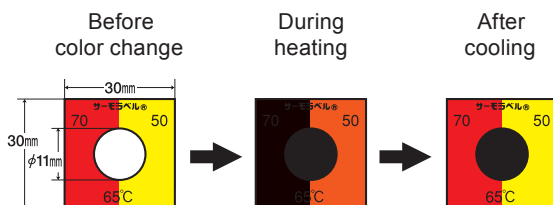

Type	Temperature-indicating element (irreversible)			Base (reversible)		JAN code
	Color-change temperature°C	Color-change	Size	Color-change temperature (Low-temperature color ↔ high-temperature color)	Size	
TB-65	65	White → Black	φ11mm	70°C Red ↔ Dark brown-purple 50°C Yellow ↔ Yellowish orange	30×30mm	4582130421734
TB-70	70	White → Red-orange				4582130421741
TB-75	75	White → Dark red				4582130421758
TB-80	80	White → Blue				4582130421765
TB-85	85	White → Deep indigo				4582130421772
TB-90	90	White → Red				4582130421789

40 labels per box

# Temperature label for Vacuums

Irreversible

**POINT!!** Check temperature in 1Pa to normal pressure environments at a single glance

## Features

- Temperature monitoring labels for use in 1Pa to normal pressure environments.
- Monitor temperature without wires or power simply by affixing the label to the area where temperature is to be monitored.
- The temperature-indicating part changes color irreversibly from pale yellow to black when the specified temperature is reached, allowing the temperature history to be traced.
- Measurements with color-change accuracy of  $\pm 2-4^{\circ}\text{C}$  are possible even under reduced pressure.
- Labels are made using low-outgassing materials to reduce the release of outgas.

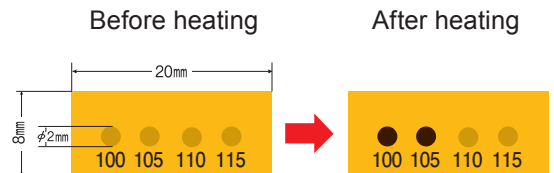

\* We can see the area has been heated to around 105°C.

Type	Temperature combination °C	Before color change	After color change	Color-change accuracy	JAN code
VL-40	40-45-50-55	Pale yellow	Black	$\pm 2^{\circ}\text{C}$	4582130423202
VL-60	60-65-70-75	Pale yellow	Black		4582130423219
VL-80	80-85-90-95	Pale yellow	Black		4582130423226
VL-100	100-105-110-115	Pale yellow	Black		4582130423233
VL-120	120-125-130-135	Pale yellow	Black	$\pm 4^{\circ}\text{C}$	4582130423240
VL-140	140-150-160-170	Pale yellow	Black		4582130423257
VL-180	180-190-200-210	Pale yellow	Black		4582130423264

10 labels per box

Irreversible

# Thermo Proof

## Features

- Thermo Paint™ in label form.
- Special adhesive on the backing enables affixing to surfaces.

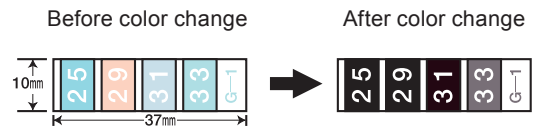

\* Colors shown are approximate colors.

Type	Indication	Color-change temperature	Original color	Color-change	JAN code
G-1	25	250°C	Light greenish blue	Reddish gray	4582130422120
	29	290°C	Light pink	Black	
	31	310°C	Bright bluish gray	Brown-black	
	33	330°C	Light blue-green	Gray-black	
G-2	※36	360°C	White	Brownish gray	4582130422137
	41	410°C	Blue	Brown white	
	44	440°C	White	Greenish gray	
	45	450°C	Purple	White	

※ Non-RoHS Compliant

10 labels per box

## Caution on Use

- For color-change characteristics, refer to the technical brochure for irreversible Thermo Paint™.
- Store in a dark place at room temperature.
- At temperatures below 20°C, the flexibility of labels may deteriorate, causing cracks to appear.
- At temperatures below 15°C, the adhesive power of labels may deteriorate and they may no longer stick. In such instances, adjust the temperature of both the label and target surface to around 25°C.
- The adhesive power of labels deteriorates over time. You are advised to use the labels as soon as possible after purchase.
- Products should be used within 1 year of purchase.



**Features**

- The color changes if heated to above the specified temperature.
- Available at a lower price depending on the quantity ordered.
- Color-change temperature, color tones and designs can be modified to suit the application.

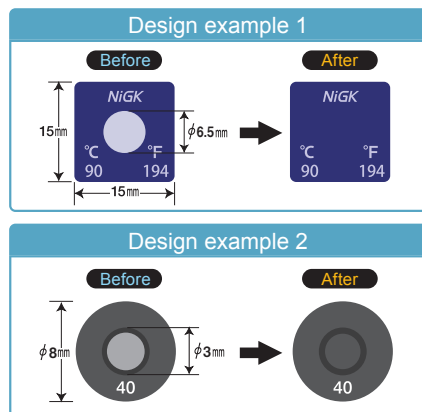

POINT!! Show current temperature as a number (in green)

**Features**

- Encapsulated liquid crystals are printed to polyester film using a special technique.
- Color changing occurs as numbers appear and disappear. Simply take the green number as the current temperature.
- The numbers change color in this order as the temperature rises: black → red-brown → green → blue → navy blue.
- As the temperature decreases, the numbers return to their original color in reverse order.

**D**

- Ascertain the current temperature from a liquid-crystal indicator

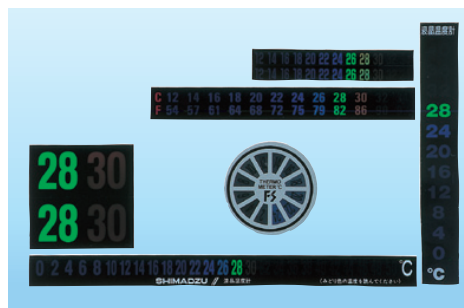

Example of a customized design

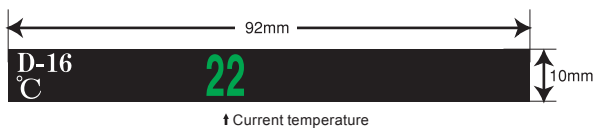

Type	Temperature range °C	Temperature interval	Color-change accuracy	JAN code
D- M6	- 6~ 14	2°C	±0.5°C	4582130422663
D- 06	6~ 34			4582130422670
D- 16	16~ 36			4582130422687
D- 38	38~ 58			4582130422694
D- 50	50~100	5°C	±2.0°C	4582130422700

30 labels per box

**Caution on Use**

- If DIGITAL THERMO TAPE™ is left for long periods in areas exposed to direct sunlight or areas of high humidity, the UV light or moisture may affect the properties, and therefore the color-changing capability, of the liquid crystals.
- DIGITAL THERMO TAPE™ has no resistance to acids and alkalis.
- Avoid contact with organic solvents.
- With D-50, the numbers may start to pale if heated for around 10 hours at 100°C, but color-changing performance will not be affected.
- Also, green numbers may appear simultaneously in low- and high-temperature areas during temperature decrease. In this case, the higher temperature is the current temperature.
- As a guideline, this product should be used indoors and for up to 3 years.

Irreversible **UV LABEL™**

**POINT!!** Confirm UV irradiation using color

**Features**

- Changes from a non-colored state to a colored state when exposed to UV light.
- The change in color can be used to confirm the level of UV irradiation.
- Once changed, the color is irreversible and will not disappear.
- Four types of varying sensitivity are available for different purposes.
- Adhesive on the backing allows easy affixing to diverse surfaces.

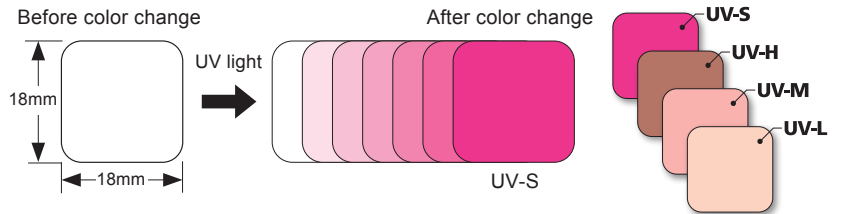

(Table1) Color Chart

Type	Irradiation Level	
	Low	High
<b>UV-S</b> Super-high sensitivity		
<b>UV-H</b> High sensitivity		
<b>UV-M</b> Medium sensitivity		
<b>UV-L</b> Low sensitivity		

(Table2) Test results based on our test conditions※

Light Source	Irradiation dose (mJ/cm <sup>2</sup> )	Results(approx.) Reference
Metal-halide lamp	1048	
Metal-halide lamp	3339	
Metal-halide lamp	5508	
Sunlight	132480	

※Color results in (table2) depend on the irradiation device, test procedure and product lot.

100 labels per box

**How to use**

- UV LABEL gives no quantitative information, but gives only qualitative information by color-change.
- The coloring result depends on multiple factors. The same radiation intensity and wavelength do not necessarily result in the same color result if the other conditions and the machine are different.
- Firstly, you get the reference color data (A) with a specific cycle (B) and lamp (C).
- As long as the B and C are same, the result should be A.
- To avoid the difference between lot, you are recommended to get a new reference data for new lot.

**Applications**

- Determining the hardness of UV-curable resins (inks, paints, adhesives, etc.)
- Maintenance (determining the time for replacement) of UV lamps (metal-halide, mercury-vapor, germicidal lamps)
- Checking sunlight UV levels
- Checking gamma-ray or electron beam irradiation (S, H)

Irreversible **Customized UV LABEL™**

Application Product

**Features**

- We customize sizes, shapes and designs at your request.
- In general, sensitivity and color changing tone will be the same as for the standard product.
- Price and delivery dates vary according to design and quantity. Please inquire for details.

**Examples**

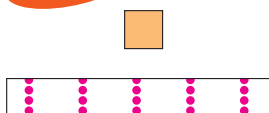

Tape: For use together with a labeler in monitoring an irradiation line

Ultra-compact size: For small target areas (e.g. 5×5mm)

Other: Large size for checking UV dose distribution (e.g. A4 size)

**Caution on Use**

- Color tones will vary according to the irradiation conditions.
- The labels change color even from exposure to room lighting. Avoid exposing unused labels to light.
- For UV-S and UV-H types, colors may fade if the color change is insufficient or if stored in hot environment after color change.
- Do not apply directly to skin.
- Please do not cut the label to maintain the adhesion strength.





**Features**

- Clear color-change with UV radiation exposure.
- Remain unchanged after the color-change reaction.
- Just apply on the object to be monitored.
- Usable for UVA wavelength (365nm or longer) that conventional types did not cover.

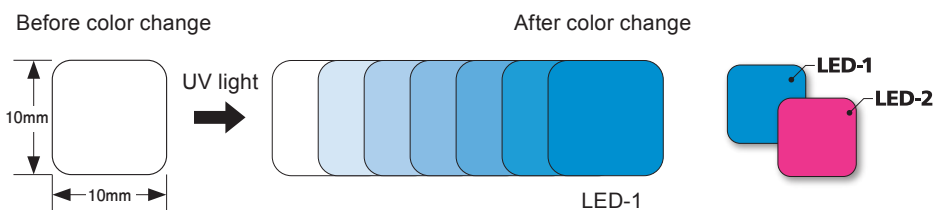

(Table1) Color Chart

Type	JAN code	Irradiation Level					
		Low					High
LED-1	4582130423370	[White]	[Light Blue]	[Medium Blue]	[Dark Blue]	[Very Dark Blue]	[Darkest Blue]
LED-2	4582130423394	[White]	[Light Pink]	[Medium Pink]	[Dark Pink]	[Very Dark Pink]	[Darkest Pink]

(Table2) Test results based on our test conditions※

Light Source	Irradiation dose (mJ/cm <sup>2</sup> )	Results(approx.) Reference
UV-LED lamp (wavelength : 385nm)	179	[Blue Reference]
	2790	[Pink Reference]

※Color results in (table2) depend on the irradiation device, test procedure and product lot.

100 labels per box

**How to use**

- UV LABEL for LED gives no quantitative information, but gives only qualitative information by color-change.
- The coloring result depends on multiple factors. The same radiation intensity and wavelength do not necessarily result in the same color result if the other conditions and the machine are different.
- Firstly, you get the reference color data (A) with a specific cycle (B) and lamp (C).
- As long as the B and C are same, the result should be A.
- To avoid the difference between lot, you are recommended to get a new reference data for new lot.

**Caution on Use**

- Color tones will vary according to the irradiation conditions.
- The labels change color even from exposure to room lighting. Avoid exposing unused labels to light.
- Do not apply directly to skin.
- Please do not cut the label to maintain the adhesion strength.



Irreversible

**RETOMARK™****Features**

- Three types available for high-temperature boil-in-bags sterilization down to low-temperature boiling sterilization. Color tones also vary depending on heating temperature and time, allowing different conditions to be detected with the same type. Select a RETOMARK™ according to your intended conditions.
- As it is heated, the color of the indicator gradually turns from cream to brown.

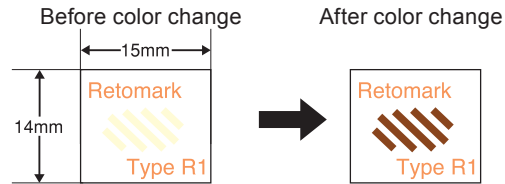

Type	Color-change temperature (°C)	Heating time (min.)	Applications	JAN code
R1	AC110-134	5 - 30	High-temperature retort sterilization	4582130422748
R2	AC100-120	5 - 15	Retort sterilization	4582130422755
	Boil 90-100	30 - 120		
R3	Boil 70-100	3 - 60	Boiling sterilization	4582130422762

500 labels per box

**Color-Change Guides**

The guides below show color tone changes when heated at a specific temperature.

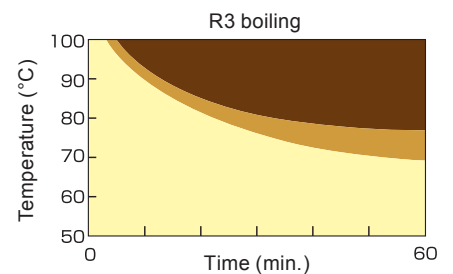
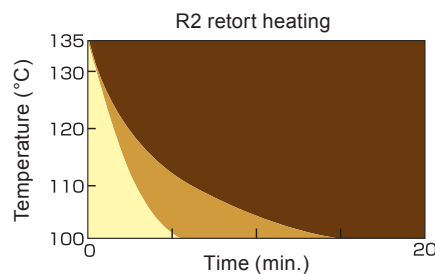
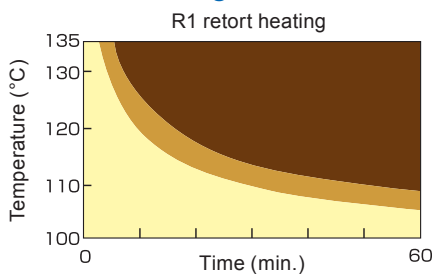
**Caution on Use**

- Actual color tones may differ from the above guides. Please confirm color tones under your intended usage conditions in advance.
- RETOMARK™ gradually turns brown if stored for a long period of time at room temperature. Please store in a refrigerator both before and after use.

Irreversible

**DEW LABEL™****POINT!!** Checks for dew condensation using color**Features**

- Uses color changes to confirm the presence of dew.
- The color change is irreversible. Once changed, the color will not return to the original color, even if dried.
- Adhesive on the backing allows easy affixing to diverse surfaces.
- Labels with customized sizes and designs can be supplied on request.

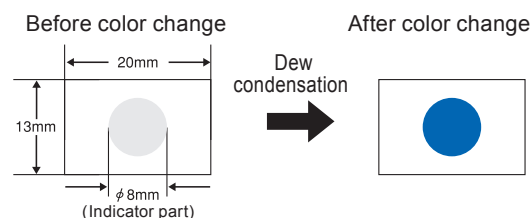

\* Color changing varies according to the dew conditions (surrounding temperature/humidity, surface temperature/heat capacity of the object, wind conditions, etc.). Too much water deposited on the label may result in the pigment running and no color appearing.

Type	Color-change	JAN code
D-1	Gray → Blue	4582130422861

200 labels per box

# Applications of Temperature Labels

## 1. Monitoring manufacturing process

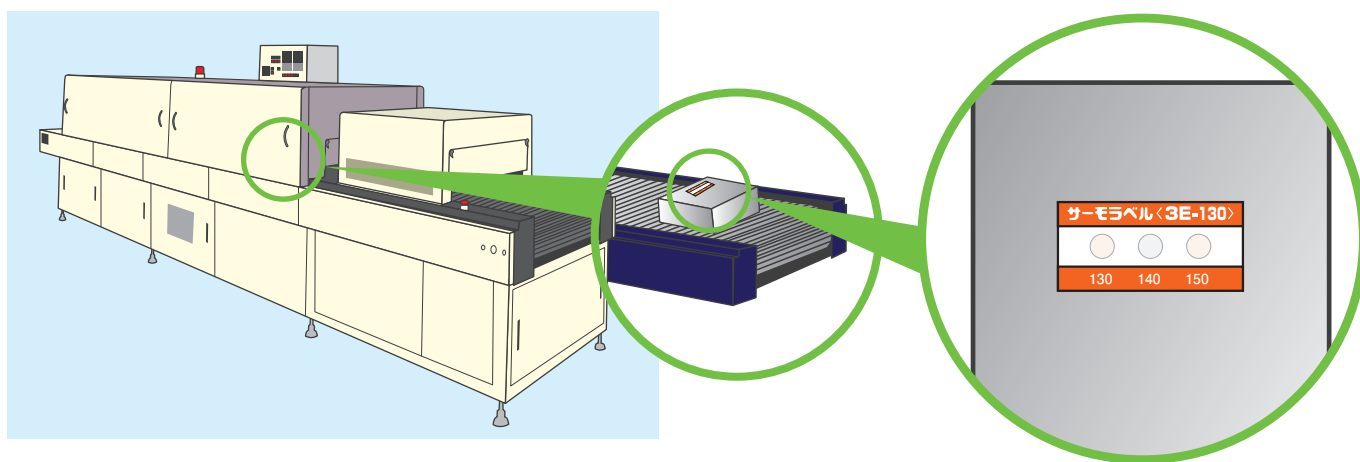

Example of affixing 3E-130

### \*Electric ovens in a manufacturing line

- ✓ Recommendation: Irreversible type  
(Label can check if the temperature reaches the set point)

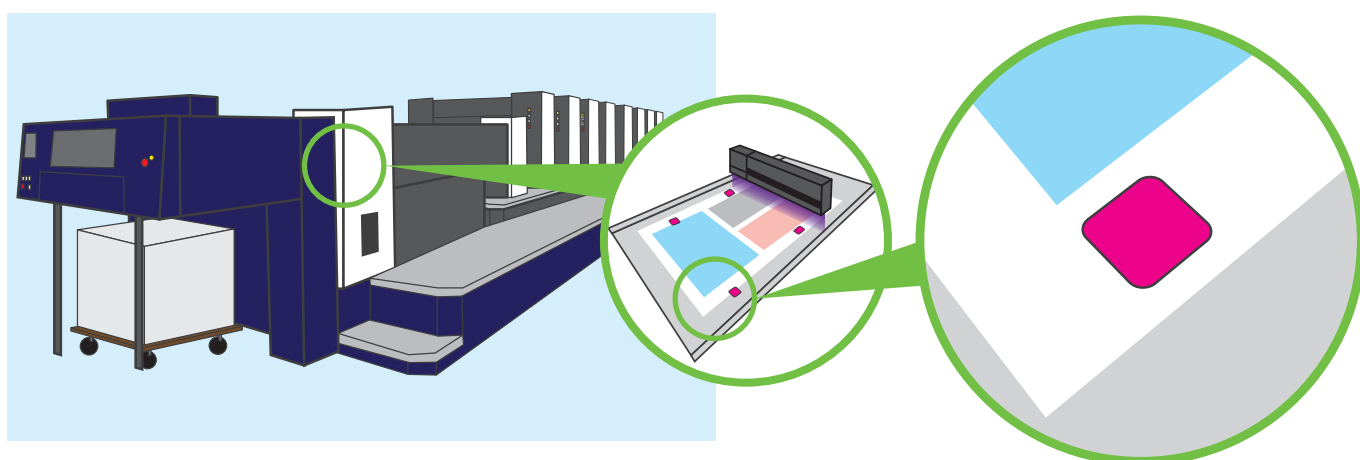

Example of affixing UV-S

### \*UV irradiation process for printings or manufacturing

- ✓ Recommendation: "UV LABEL for LED" or "UV LABEL"  
(Label can check if the UV intensity level was good enough)

## 2. Monitoring abnormal heat

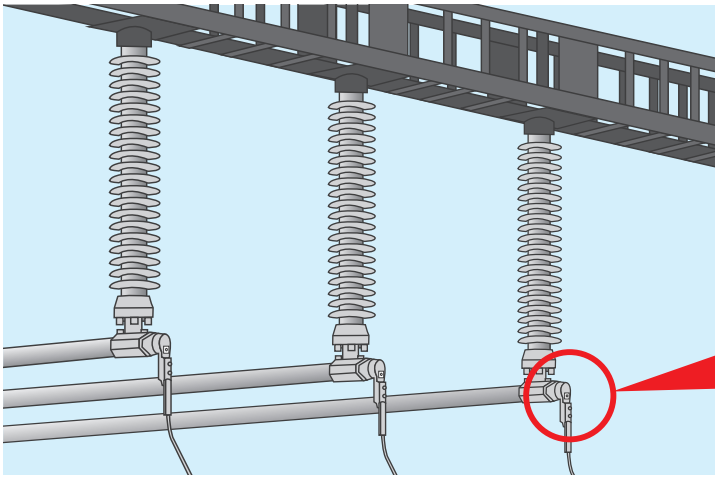

### \*Joint of electrical transforming equipment

- ✓ Recommendation: Irreversible type  
(Confirming abnormal heat record is possible)

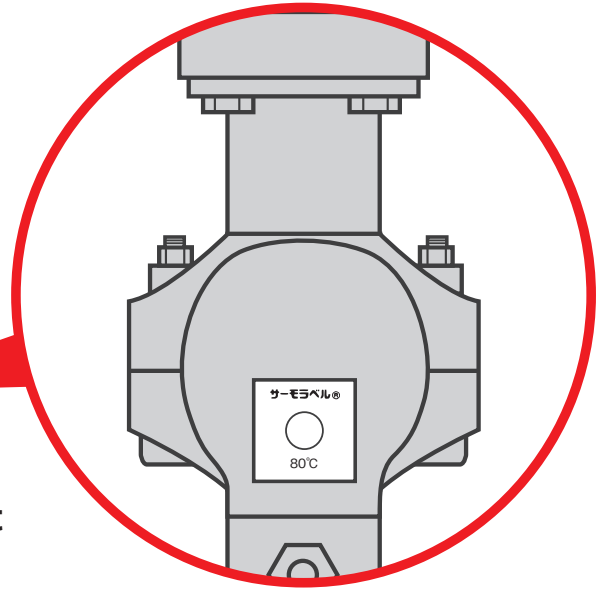

Example of affixing LI-80

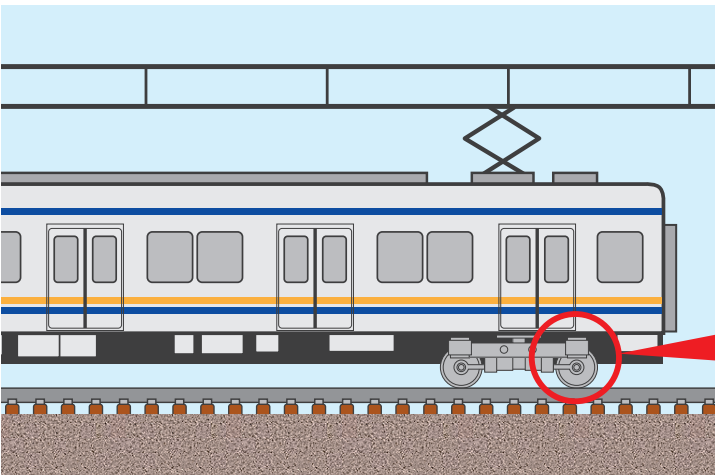

### \*Train Axles

- ✓ Recommendation: Irreversible type  
(Finding out an indication of axle trouble)

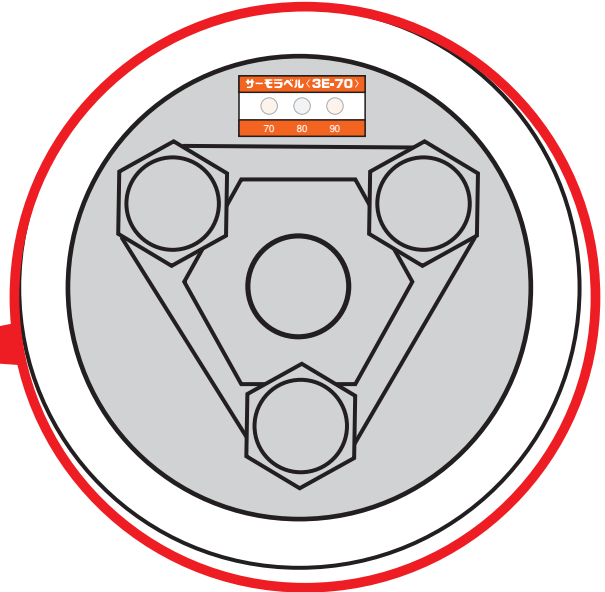

Example of affixing 3E-70

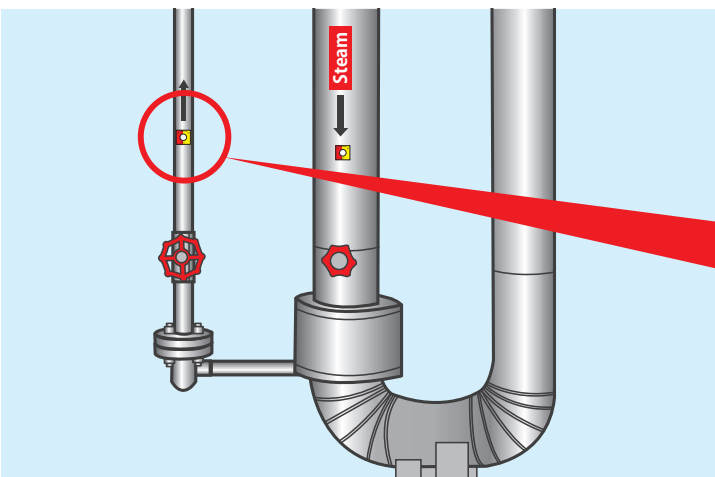

### \*Pipings for steam or hot water

- ✓ Recommendation: Reversible type  
(Preventing any burn in a work place)

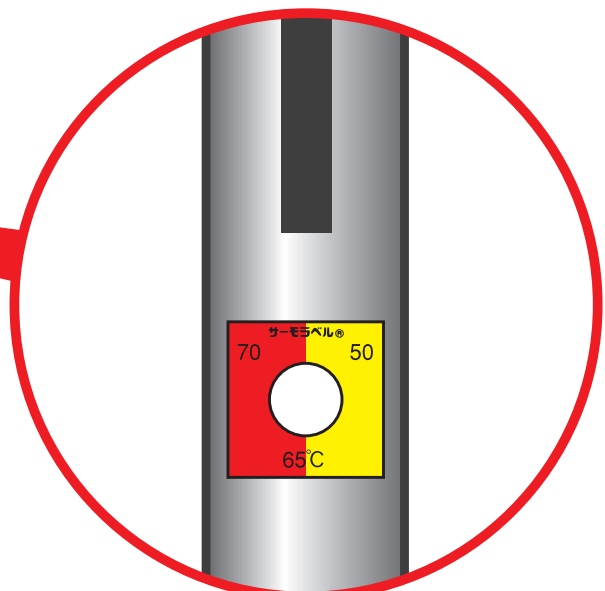

Example of affixing TB-65

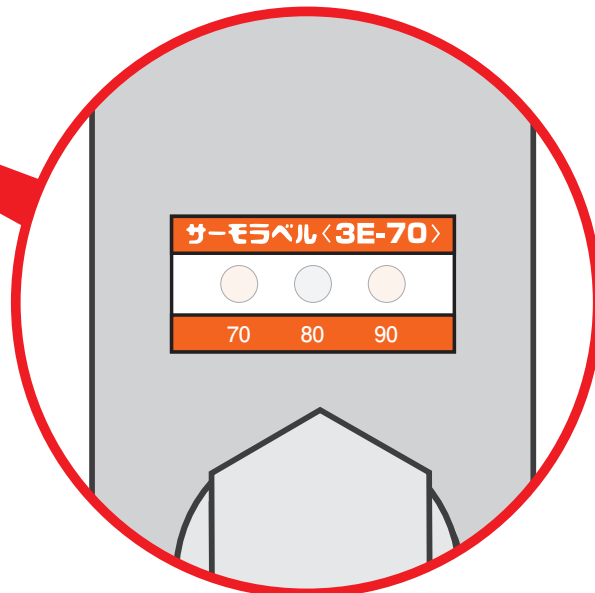
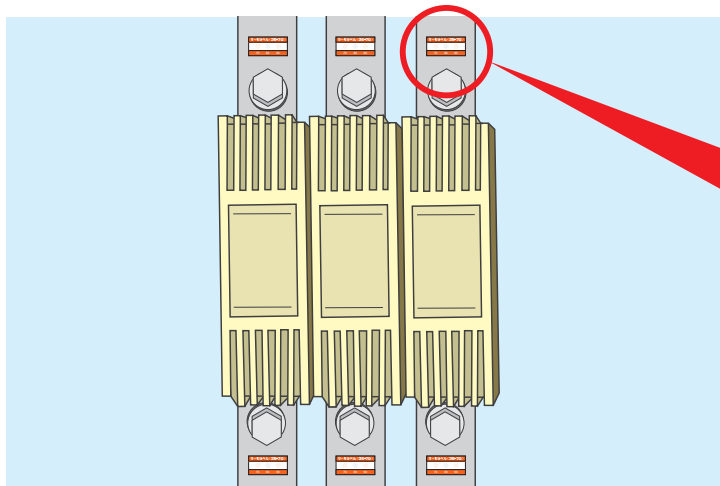

Example of affixing 3E-70

**\*Busbars in switchboard**

- ✓ Recommendation: Irreversible type  
(Confirming abnormal heat due to looseness)

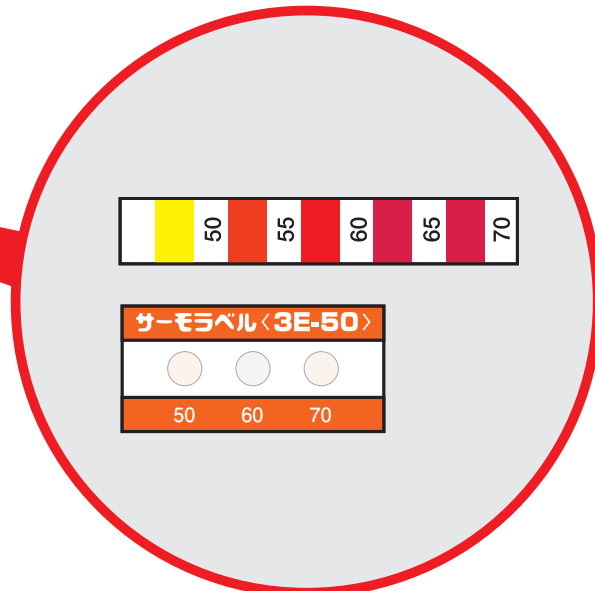
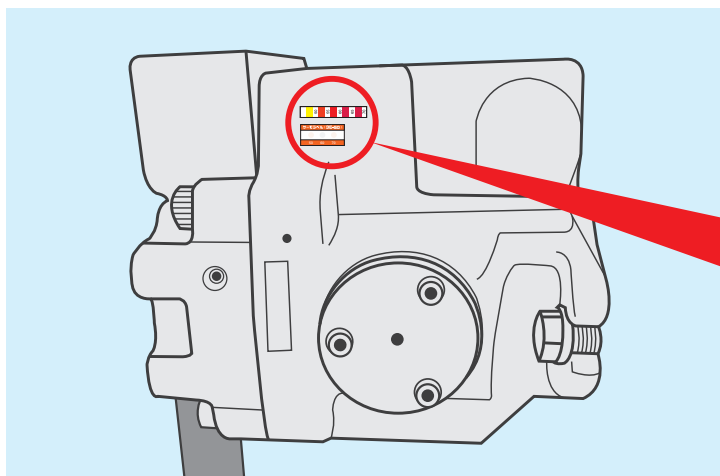

Example of affixing THERMO SHEET C and 3E-50

**\*Motors or Oil pressure pumps**

- ✓ Recommendation: Irreversible and Reversible type  
(Detecting abnormal heat to avoid any defects)

**3. Monitoring Disinfection process for foods or related goods**

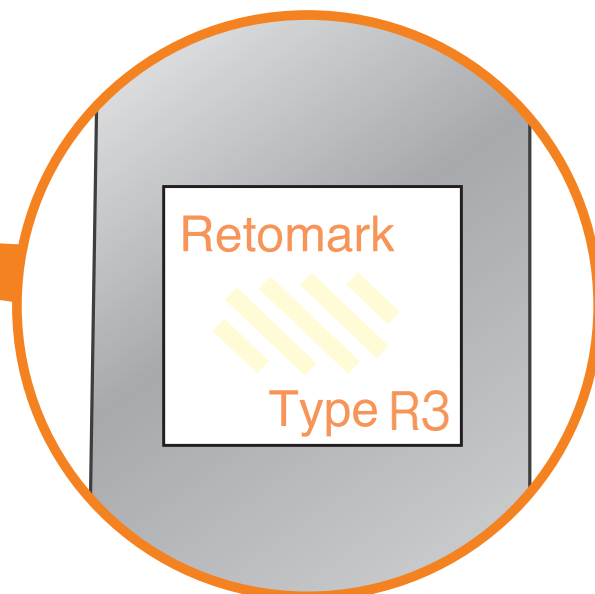
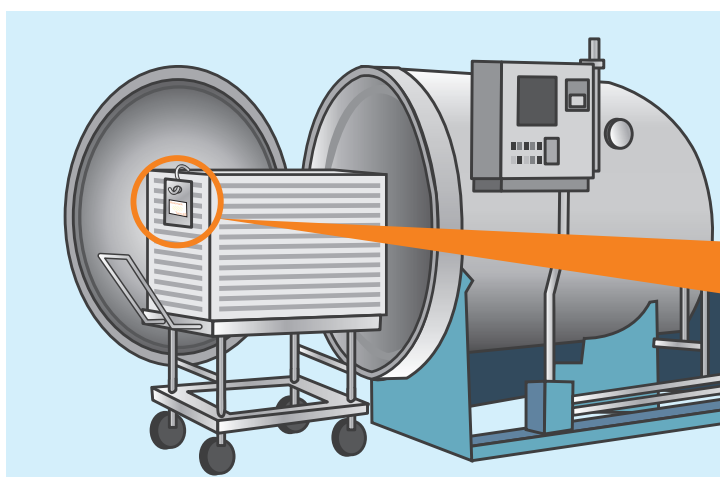

Example of affixing R3

**\*Retort ovens in a food processing**

- ✓ Recommendation: Retomark R1, R2 and R3  
(Confirming certain time and temperature for disinfection)

# Temperature Indicating Materials – Usage Examples

**No power supply, no wiring required.**  
**Just affix the label to the areas to be monitored.**

**For the maintenance of Power Distribution Equipment**

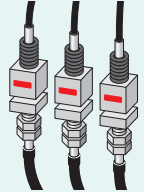

**Combination Label**



- For checking past and current temperature

**For detecting abnormal temperature rise of the outdoor tank**

**Temperature Label LI**



- Single indicator type of high visibility

**For detecting abnormal temperature rise of the motors and pumps, etc.**

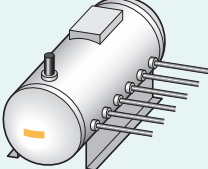

**Temperature Label 5E**



- Indicates the highest temperature

**For preventing burns from heated steam pipes**

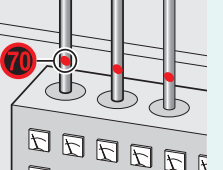

**Number THERMO WAPPEN**

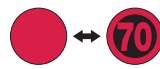

- Shows current temperature as a number

**For monitoring abnormal temperature rise of the products**

**Temperature Label Super Mini 3K**



- Indicates the highest temperature

**For detecting dew condensation in precision equipment**

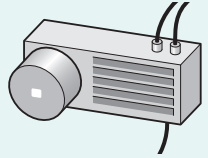

**DEW LABEL**



- Color change indicates the presence of dew

**For checking the manufacturing process**

**Heat treatment process**

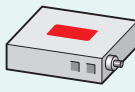

**Temperature Label 3E**



- Indicates the highest temperature

**UV irradiation process**



**UV LABEL**



- Confirms UV irradiation using color

**Retort sterilization process**

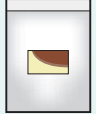

**RETOMARK**



- For monitoring moist heat or boiling sterilization

**Vacuum deposition / Dry etching process**

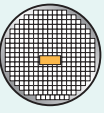

**Temperature Label for Vacuums**



- Indicates the highest temperature

**For monitoring temperature of the products**



**DIGITAL THERMO TAPE**



- Shows current temperature as a number



Product	Temperature range (°C)	Color-changing function			Usage method				Features	Page
		Reversible	Irreversible	Semi-irreversible	Affix	Paint	Draw	Place		
<b>Temperature Indicating Materials</b>										
Temperature label LI	40 to 250		●		●				Single temperature indicating model	02
Temperature label 3E	40 to 250		●		●				3 temperatures at 10°C intervals	02
Temperature label 4E	50 to 110		●		●				4 temperatures at 5°C intervals	03
Temperature label 5E	50 to 250		●		●				5 temperatures at 5°C or 10°C intervals	03
Temperature label 8E	50 to 160		●		●				8 temperatures between 50°C and 160°C at 10°C intervals	03
Temperature label F	50 to 125		●		●				Small single temperature indicating model	03
Temperature label Super Mini 1K	40 to 125		●		●				Mini-sized single temperature indicating model	04
Temperature label Super Mini 3K	40 to 150		●		●				Mini-sized type with 3 temperatures at 5°C or 10°C intervals	04
Temperature label Super Mini 3R	40 to 150		●		●				Round mini-sized type with 3 temperatures at 5°C or 10°C intervals	04
Temperature label Mini	50 to 125		●		●				Single temperature indicating model	05
Temperature label 5S	50 to 115		●		●				5 temperatures at 5°C intervals	05
THERMO TAPE™	40 to 70	●			●				Current temperature indication on strips	06
THERMO SHEET™ P-5-7	50 to 70	●			●				Checking current temperature above 50°C and 70°C	06
THERMO SHEET™ C	50 to 70	●			●				Current temperature between 50°C and 70°C, 5 temperatures at 5°C intervals	06
Number THERMO WAPPEN™	40 to 70	●			●				Number of heating temperature appears	07
Combination label A	50 to 90	●	●		●				Rectangular type for checking past and current temperature	07
Combination label TB	50 to 90	●	●		●				Round type for checking past and current temperature	07
Temperature label for Vacuums	40 to 210		●		●				Check temperature in 1Pa to normal pressure environments at a single glance	08
Thermo Proof	250 to 450		●		●				4 types of paint on a single sticker	08
DEGMARK™	40 to 140		●		●				For design flexibility and low cost	09
DIGITAL THERMO TAPE™	-6 to 100	●			●				Show current temperature as a number (in green)	09
<b>Ultraviolet indicating material</b>										
UV LABEL™	—		●		●				Changes color with UV light	10
Customized UV LABEL™ (UV Label™ Application Product)	—		●		●				Create your own original design	10
UV LABEL for LED™	—		●		●				Changes color with UV light	11
<b>Heat sterilization indicating material</b>										
RETOMARK™	70°C to 134°C 3-120 min.		●		●				For monitoring retort and boiling sterilization	12
<b>Dew indicating material</b>										
DEW LABEL™	—		●		●				Color change indicates the presence of dew	12

Please inquire about usage environments

Specifications of products presented in this catalog may change without prior notice.  
Indicator color changes in this catalog are printed and may differ slightly from actual colors.  
Please also feel free to contact us about chemical indicators, which are not included in this catalog.  
Names of products presented in this catalog are trademarks or registered trademarks of NiGK Corporation only in Japan.

**ISO 9001 Certified**

NiGK Corporation products undergo rigorous quality management in accordance with the ISO 9001 standard before delivery to the customer.

■ Distributor

■ Manufacturer

—— From the Ocean to Outer Space ——

**NiGK Corporation**

Head Office & Kawagoe Plant  
21-2 Matoba-shinmachi, Kawagoe, Saitama, 350-1107 Japan  
FAX : +81-(0)49-231-1334

Tokyo Sales Office  
TOKYU BLDG. EAST NO.5, 2-25-5 Minami-ikebukuro  
Toshima, Tokyo, 171-0022 Japan  
TEL : +81-(0)3-3986-3910 (English)  
FAX : +81-(0)3-3983-8286  
E-mail : indicators@nichigi.co.jp

Website : [www.nichigi.co.jp/en](http://www.nichigi.co.jp/en)



NiGK Corporation